



# USER MANUAL















## **MBF6000 / MBF6010**

### Body Composition Analyzer



Please keep the instruction manual at hand all the time for future reference.

## Explanation of Graphic Symbols on Label/Packaging

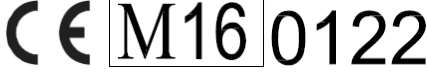
	Caution, consult accompanying documents before use		Separate collection for waste of electrical and electronic equipment, in accordance with Directive 2002/96/EC
	Manufacturer of medical device		Manufacturing year of medical device
	Carefully read user manual before installation and usage, and follow instructions for use.		Medical electrical equipment part with Type BF applied part
	Device catalogue number		Authorized representative in the European Community
	Manufacturer's batch or lot number		Device is a medical device
	Serial number		Unique Device Identifier
		Device conforms to 93/42/EEC as amended by 2007/47/EC Medical Device Directive. Four digit number refers to Notified Body.	
		Device complies with International Organization of Legal Metrology (Class III) requirements (verified models only)	
		Device complies with EC directives (verified models only)  <b>M</b> : Conformity label in compliance with Directive 2014/31/EU for non-automatic weighing instruments  <b>16</b> : Year in which conformity verification was performed and the CE label was applied. (ex: 16=2016)  <b>0122</b> : Refers to Notified Body for metrology	

# Warning

During measurement, this machine will send a low level imperceptible electrical current throughout the body. Individuals with implanted medical devices, such as:

1. Pacemakers
2. Electronic lungs and other electronic medical life support equipment
3. ECG devices

must not use this machine, as the electric current may affect the implanted device, endangering lives.

Warning: To avoid electric shock, this device should be plugged into a grounded electrical outlet

## **Copyright Notice**

### **Charder Electronic Co., Ltd.**

No.103, Guozhong Rd., Dali Dist., Taichung City 41262 Taiwan

Tel: +886-4-2406 3766

Fax: +886-4-2406 5612

Website: [www.chardermedical.com](http://www.chardermedical.com) E-mail: [info\\_cec@charder.com.tw](mailto:info_cec@charder.com.tw)

Copyright© Charder Electronic Co., Ltd. All rights reserved.

This user manual is protected by international copyright law. All content is licensed, and usage is subject to written authorization from Charder Electronic Co., Ltd. (hereinafter Charder) Charder is not liable for any damage caused by a failure to adhere to requirements stated in this manual. Charder reserves the right to correct misprints in the manual without prior notice, and modify the exterior of the device for quality purposes without customer consent.



Charder Electronic Co., Ltd.  
No. 103, Guozhong Rd., Dali Dist.,  
Taichung City, 41262 Taiwan

# CONTENTS

<b>I. Safety Notes</b>	<b>5</b>
A. General Information	5
B. EMC Guidance and Manufacturer's Declaration	8
<b>II. Installation</b>	<b>12</b>
A. Assembly	12
B. Inserting Batteries	13
C. Using Adapter	15
D. Attaching Height Rod to Column	16
E. Attaching Thermal Printer	18
<b>III. Exterior and Panel</b>	<b>20</b>
A. Quick Guide to components	20
B. Indicator and Key Functions	21
C. Display layout	22
<b>IV. Using Device</b>	<b>23</b>
A. Setup Device for Measurement	23
B. Pre-Tare	24
C. Conduct Measurement	25
D. Print	26
E. Measurement Results Explained	27
F. About Bioelectrical Impedance Measurement	30
<b>V. Device Setup</b>	<b>32</b>
A. Setting Time & Date	32
B. Device Setup	33
<b>VI. Setup USB Connection to PC</b>	<b>35</b>
A. Hyper Terminal	35
<b>VII. Wireless Connection</b>	<b>37</b>
<b>VIII. Troubleshooting</b>	<b>37</b>
<b>IX. Product Specifications</b>	<b>40</b>
A. Device Information	40
B. Output Items (Display and Print-out)	41
C. Power Adapter Standards	42
<b>X. Declaration of Conformity</b>	<b>44</b>



## I. Safety Notes

### A. General Information

Thank you for choosing this Charder Medical device. It is designed to be easy and straightforward to operate, but if you encounter any problems not addressed in this manual, please contact your local Charder service partner.

Before beginning operation of the device, please read this user manual carefully, and keep it in a safe place for reference. It contains important instructions regarding installation, proper usage, and maintenance.

### Intended Use

This device is intended to estimate body composition by measuring and monitoring the weight and bioelectrical impedance of subjects who can stand unassisted. This device is only for professional use at clinics and hospitals.

### Contraindications

During measurement, this machine will send a low level imperceptible electrical current throughout the body. Individuals with implanted medical devices, such as:

- Pacemakers
- Electronic lungs and other electronic medical life support equipment
- ECG devices

must not use this machine, as the electric current may affect the implanted device, endangering lives.

### General Handling

- Device should be placed on stable, flat, solid, non-slippery surface.
- Usage on soft surfaces (ex: carpet) may result in inaccurate results.
- Ensure all parts are properly locked and tightened before operating the device.
- Device is intended to measure one subject at a time.

### Safety Instructions

- Batteries should be kept away from children. If swallowed, promptly seek medical assistance.
- Expected service life: 5 years.
- Always comply with appropriate regulations when using electrical components under increased safety requirements.
- Ensure voltage marked on power supply matches mains power supply.

- The device is intended for indoor use only.
- Observe permissible ambient temperatures for use

### **Environmental**

- All batteries contain toxic compounds; batteries should be disposed of via designated competent organizations. Batteries should not be incinerated.

### **Cleaning**

- Device surface should be cleaned using alcohol-based wipes. Corrosive cleansing liquids should not be used. Pressure-washers should not be used.
- Do not use large amounts of water when cleaning the device, as it may cause damage to the internal electronics.
- Always disconnect device from mains power before cleaning.

### **Maintenance**

- Device does not require routine maintenance. However, regular checking of accuracy is recommended; frequency to be determined by level of use and state of device. If results are inaccurate, please contact local distributor.

### **Warranty/Liability**

- The period of warranty shall be eighteen (18) months, beginning on the date of purchase. Please retain your receipt as proof of purchase.
- No responsibility shall be accepted for damage caused through any of the following reasons: unsuitable or improper storage or use, incorrect installation or commissioning by the owner or third parties, natural wear and tear, changes or modifications, incorrect or negligent handling, chemical, electrochemical, or electrical interference.
- All maintenance, technical inspections, and repairs should be conducted by an authorized Charder service partner, using original Charder accessories and spare parts. Charder is not liable for any damages arising from improper maintenance or usage.

### **Disposal**

- This product is not to be treated as regular household waste, but should be taken to a designated collection points for electronics. Further information should be provided by local waste disposal authorities.



## **Warning**

- Only the original adapter should be used with the device. Using an adapter other than the one provided by Charder may cause malfunction.
- Do not touch the power supply with wet hands.
- Do not crimp the power cable, and avoid sharp edges.
- Do not overload extension cables connected to the device.
- Route cables carefully, to avoid tripping.
- Keep device away from liquids.
- Do not remove the plug by yanking on the cable.
- Use only a correctly wired (100-240VAC) outlet, and do not use a multiple outlet extension cable.
- Do not under any circumstances dismantle or alter the device, as this could result in electric shock or injury as well as adversely affect the precision of measurements.
- Do not place the device in direct sunlight, or in close proximity to an intense heat source. Excessively high temperatures may damage the internal electronics.



## **Caution**

### **Usage of Results**

- The MBF6000/MBF6010 is not a diagnostic device.
- BIA results are calculated based on impedance values validated with representative population studies and statistical analysis. As such, the technique is best suited for tracking progress for an individual over a period of time, or for categorizing large groups of people, rather than used as a one-time analysis. Accuracy of results is highly dependent on proper measurement procedure. Please follow instructions carefully for best results.

### **Incident Reporting**

- Any serious incident that has occurred in relation to the device should be reported to the manufacturer, EU representative (if device is used in EU member state), and competent authority of user/subject's member state

## B. EMC Guidance and Manufacturer's Declaration

<b>Guidance and manufacturer's declaration-electromagnetic emissions</b>		
The MBF6000/MBF6010 Body Composition Analyzer is intended for use in the electromagnetic environment specified below. The customer or the user of the device should assure that it is used in such an environment.		
<b>Emission test</b>	<b>Compliance</b>	<b>Electromagnetic environment-guidance</b>
RF emissions CISPR 11	Group 1	The device uses RF energy only for its internal function. Therefore, its RF emissions are very low and are not likely to cause any interference in nearby electronic equipment.
RF emissions CISPR 11	Class B	The device is suitable for use in all establishments, including domestic establishments and those directly connected to the public low-voltage power supply network that supplies buildings used for domestic purposes.
Harmonic emissions IEC 61000-3-2	Class A	
Voltage fluctuations /flicker emissions IEC 61000-3-3	Compliance	

<b>Guidance and manufacturer's declaration-electromagnetic immunity</b>			
The MBF6000/MBF6010 Body Composition Analyzer is intended for use in the electromagnetic environment specified below. The customer or the user of the device should assure that it is used in such an environment.			
<b>Immunity test</b>	<b>IEC 60601 test level</b>	<b>Compliance level</b>	<b>Electromagnetic environment-guidance</b>
Electrostatic discharge(ESD) IEC 61000-4-2	<u>± 8 kV contact</u> <u>± 2 kV, ± 4 kV,</u> <u>± 8 kV, ± 15 kV</u> <u>air</u>	<u>± 8 kV contact</u> <u>± 2 kV, ± 4 kV,</u> <u>± 8 kV, ± 15 kV</u> <u>air</u>	Floors should be wood, concrete or ceramic tile. If floors are covered with synthetic material, the relative humidity should be at least 30%



Electrical fast transient/burst IEC 61000-4-4	± 2kV for power supply lines + 1kV for input/output lines	+ 2kV for power supply lines + 1kV for input/output lines	Mains power quality should be that of a typical commercial or hospital environment.
Surge IEC 61000-4-5	± 1kV line(s) to line(s) ± 2kV line(s) to earth	+ 1kV line(s) to line(s) + 2kV line(s) to earth	Mains power quality should be that of a typical commercial or hospital environment.
Voltage Dips, short interruptions and voltage variations on power supply input lines IEC 61000-4-11	<u>0% UT for 0,5 cycle</u> <u>0% UT for 1 cycle</u>  <u>70% UT(30% dip in UT) for 25 cycles</u>  <u>0% UT for 5 s</u>	<u>0% UT for 0,5 cycle</u> <u>0% UT for 1 cycle</u>  <u>70% UT(30% dip in UT) for 25 cycles</u>  <u>0% UT for 5 s</u>	Mains power quality should be that of a typical commercial or hospital environment. If the user of the device requires continued operation during power mains interruptions, it is recommended that the device be powered from an uninterruptible power supply or a battery.
Power frequency(50/60 Hz) magnetic field IEC 61000-4-8	<u>30 A/m</u>	<u>30 A/m</u>	The device power frequency magnetic fields should be at levels characteristic of a typical location in a typical commercial or hospital environment.
NOTE UT is the a.c. mains voltage prior to application of the test level.			

### Guidance and manufacturer's declaration-electromagnetic immunity

The MBF6000/MBF6010 Body Composition Analyzer is intended for use in the electromagnetic environment specified below. The customer or the user of the device should assure that is used in such an environment.

Immunity test	IEC 60601 test level	Compliance level	Electromagnetic environment-guidance
Conducted RF IEC 61000-4-6	3 Vrms 150 KHz to 80 MHz	3 Vrms 150 KHz to 80 MHz	Portable and mobile RF communications equipment should be used no closer to any part of the device including cables, than the recommended separation distance calculated from the equation applicable to
Radiated RF IEC 61000-4-3	<u>6 V in ISM bands between 0,15 MHz and 80 MHz</u> <u>80 % AM at 1 kHz</u>  3 V/m	<u>6 V in ISM bands between 0,15 MHz and 80 MHz</u> <u>80 % AM at 1</u>	

	80MHz to 2,7 GHz	<u>kHz</u> 3 V/m <u>80MHz to 2,7 GHz</u>	the frequency of the transmitter.  <b>Recommended separation distance:</b> $d = 1,2 \sqrt{P}$ $d = 1,2 \sqrt{P}$ 80MHz to 800 MHz $d = 2,3 \sqrt{P}$ 800MHz to 2,5 GHz  Where $P$ is the maximum output power rating of the transmitter in watts (W) according to the transmitter manufacturer and $d$ is the recommended separation distance in metres (m).  Field strengths from fixed RF transmitters, as determined by an electromagnetic site survey <sup>a</sup> , should be less than the compliance level in each frequency range <sup>b</sup> .  Interference may occur in the vicinity of equipment marked with the following symbol:  
--	------------------	--	--

NOTE1 At 80 MHz and 800 MHz, the higher frequency range applies.

NOTE2 These guidelines may not apply in all situations. Electromagnetic propagation is affected by absorption and reflection from structures, objects and people.

a Field strengths from fixed transmitters, such as base stations for radio (cellular/cordless) telephones and land mobile radios, amateur radio, AM and FM radio broadcast and TV broadcast cannot be predicted theoretically with accuracy. To assess the electromagnetic environment due to fixed RF transmitters, an electromagnetic site survey should be considered. If the measured field strength in the location in which the device is used exceeds the applicable RF compliance level above, the device should be observed to verify normal operation. If abnormal performance is observed, additional measures may be necessary, such as re-orienting or relocating the device.

b Over the frequency range 150 kHz to 80 MHz, field strengths should be less than 3 V/m.

**Recommended separation distance between portable and mobile RF communications equipment and the MBF6000/MBF6010 Body Composition Analyzer**

The device is intended for use in an electromagnetic environment in which radiated RF disturbances are controlled. The customer or the user of the device can help prevent electromagnetic interference by maintaining a minimum distance between portable and mobile RF communications equipment (transmitters) and the device as recommended below, according to the maximum output power of the communications equipment.

Rated maximum output power of transmitter  W	Separation distance according to frequency of transmitter m		
	150 kHz to 80 MHz $d = 1,2\sqrt{P}$	80 MHz to 800 MHz $d = 1,2\sqrt{P}$	800 MHz to 2,5 GHz $d = 2,3\sqrt{P}$
0,01	0,12	0,12	0,23
0,1	0,38	0,38	0,73
1	1,2	1,2	2,3
10	3,8	3,8	7,3
100	12	12	23

For transmitters rated at a maximum output power not listed above, the recommended separation distance  $d$  in metres (m) can be estimated using the equation applicable to the frequency of the transmitter, where  $p$  is the maximum output power rating of the transmitter in watts (W) according to the transmitter manufacturer.

NOTE1 At 80 MHz and 800 MHz, the separation distance for the higher frequency range applies.

NOTE2 These guidelines may not apply in all situations. Electromagnetic propagation is affected by absorption and reflection from structures, objects and people.

## II. Installation

### A. Assembly

1. Remove base and column from box

**NOTE:** remove entire device (column + platform) from box at the same time. Do not lift column by itself, as this may damage wire connecting measurement platform to indicator.

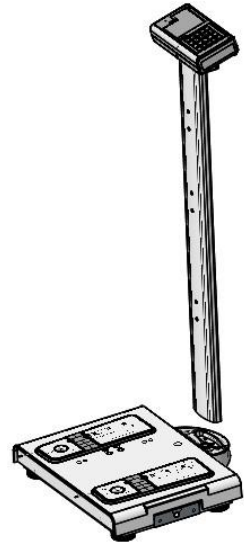

2. Fasten and tighten four screws at the bottom of the base

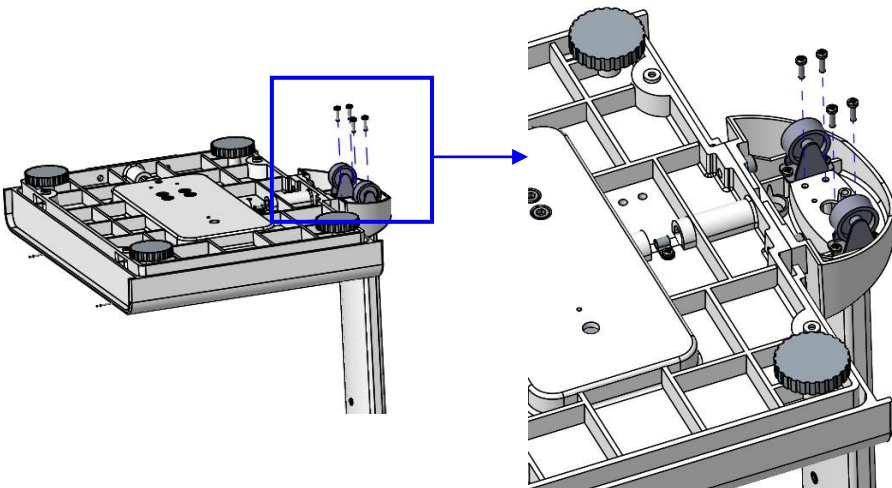

## B. Inserting Batteries

### 1. Open battery housing cover

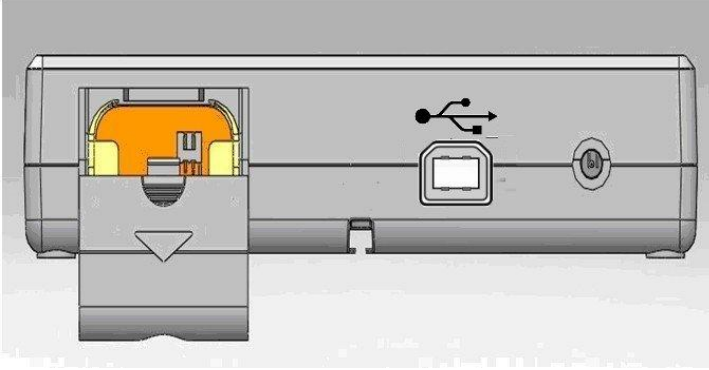

### 2. Accessing batteries

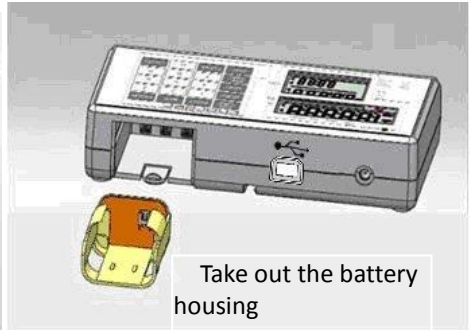
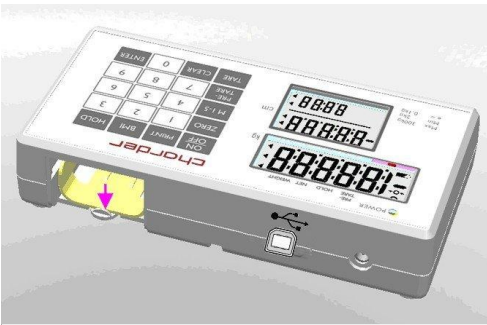

### 3. Use either rechargeable battery pack, or AA batteries

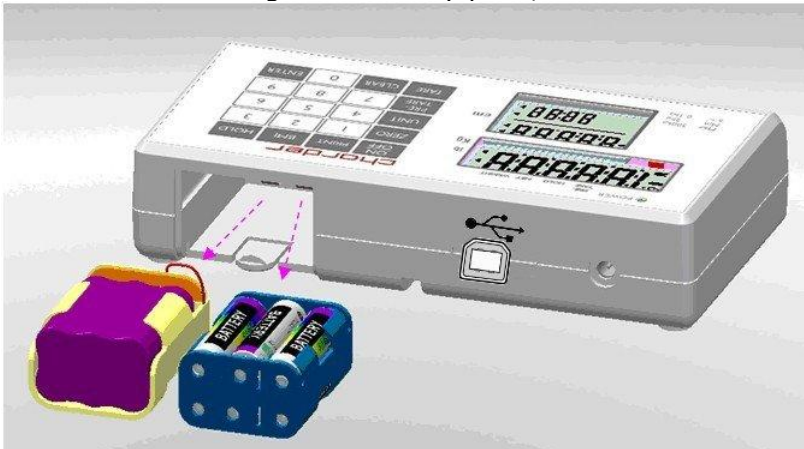

### 4. Ensure batteries are installed into the housing correctly

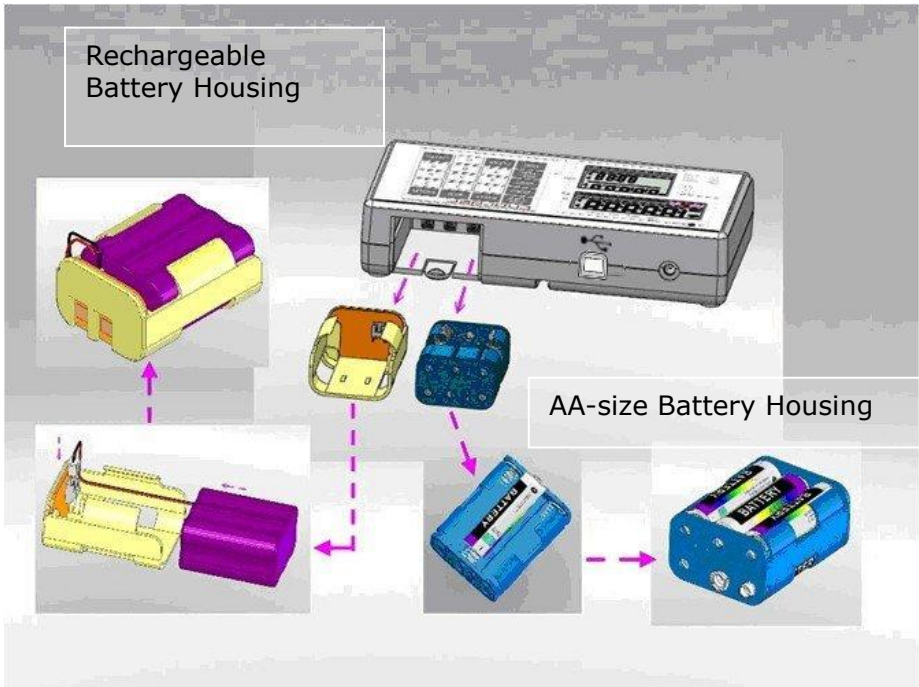

5. Install the battery housing into the compartment, and make sure the right side of housing pin is facing towards inside of the connecting position

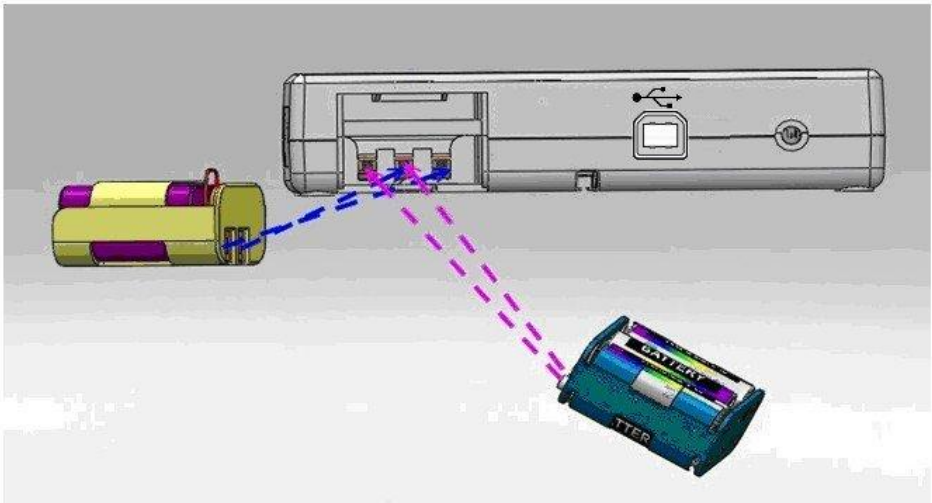

6. Slide back the cover to close the battery housing compartment. Turn on power to confirm that battery is correctly installed.

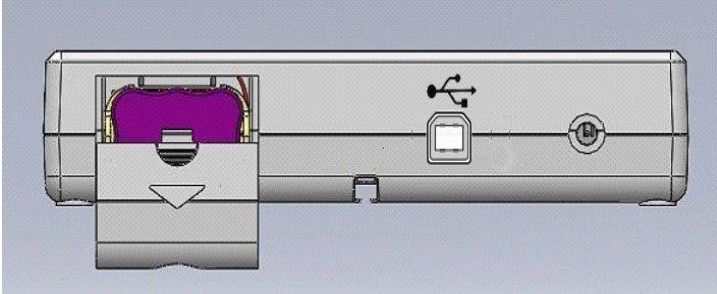

### C. Using Adapter

1. Connect adapter to indicator before connecting to mains power supply
2. Disconnect adapter from mains power supply before unplugging adapter pin from indicator.

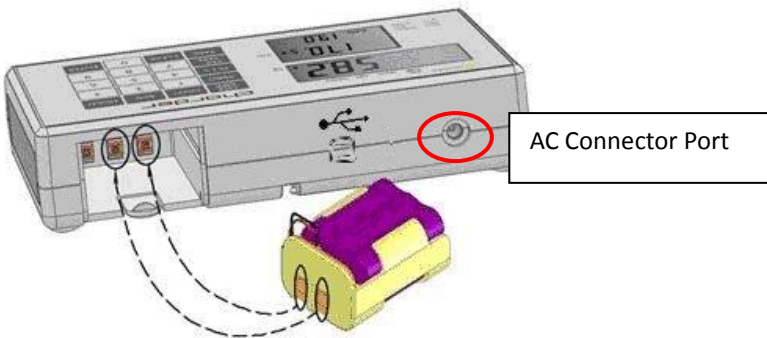

### Using Rechargeable Battery (optional)

The rechargeable battery should be recharged at least once every 3 months, regardless of if the device has been used. Battery can be charged by plugging device's exclusive adapter into AC Connector Port.

After a long period in storage (e.g. >3 months), the battery should run a full cycle (charge/discharge) to allow it to restore full capacity.

If Lo prompt displays on the LCD, please charge battery promptly to avoid battery damage.

## D. Attaching Height Rod to Column

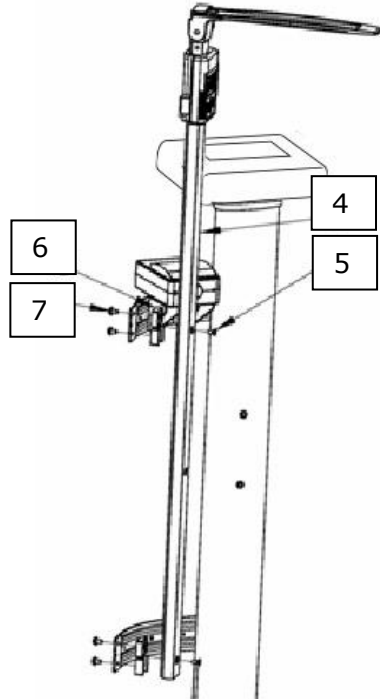
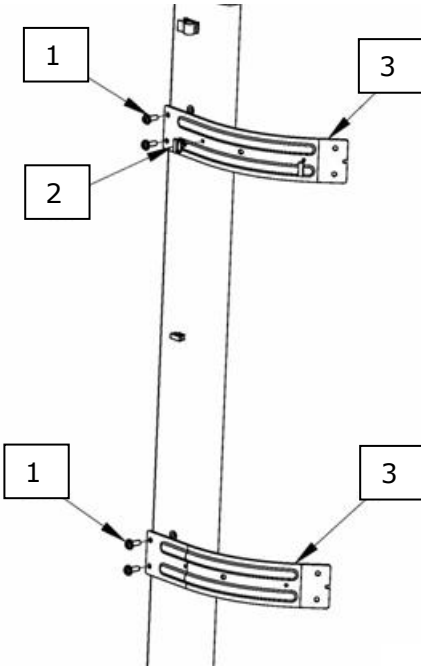

1. Attach brackets to column with round-head screws

2. Attach height rod to brackets using flat-head screws

Item	Name	Quantity
1	M5x0.8x11 round head screw	4
2	Relief Bushing	2
3	Bracket for HM200D/HM201D/HM201M	2
4	Height Rod (Compatible with: HM200D/HM201D/HM201M)	1
5	M5x10L flat head screw	2
6	Fixing block	2
7	M5x0.8x11	4



# Connecting digital height rod to indicator (HM200D/HM201D)

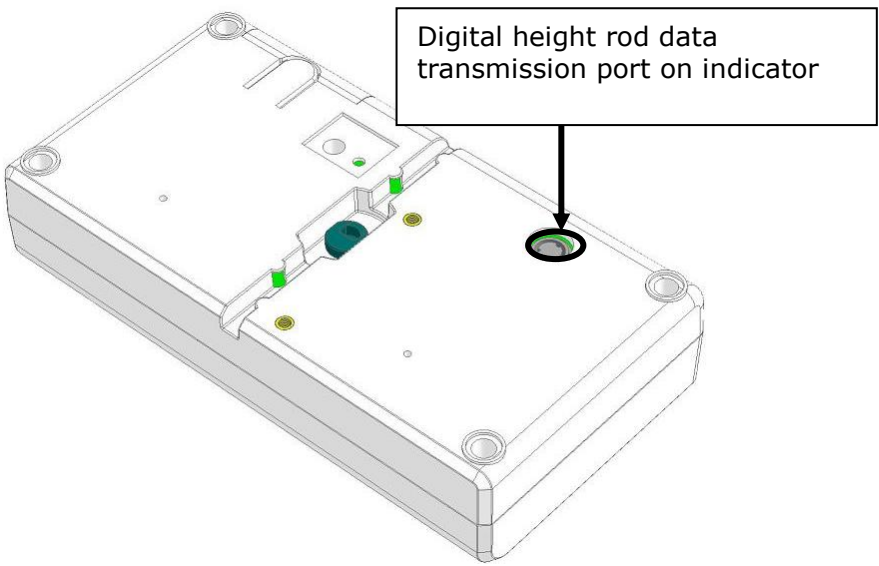
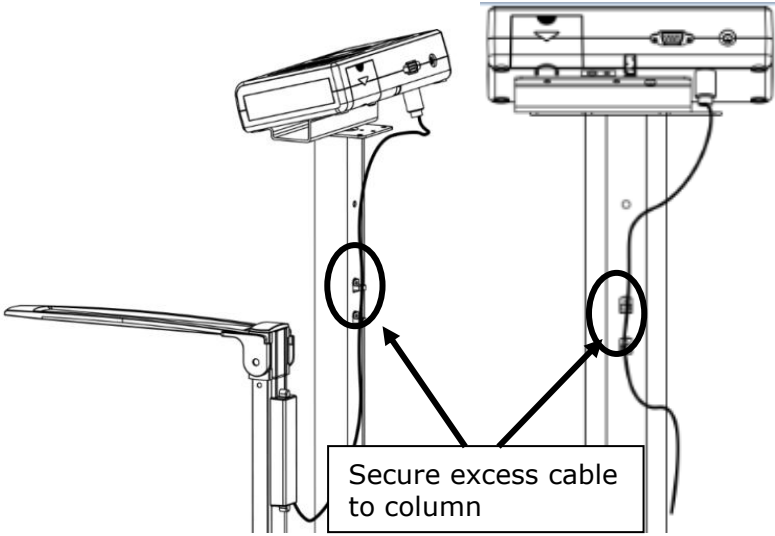

## E. Attaching Thermal Printer

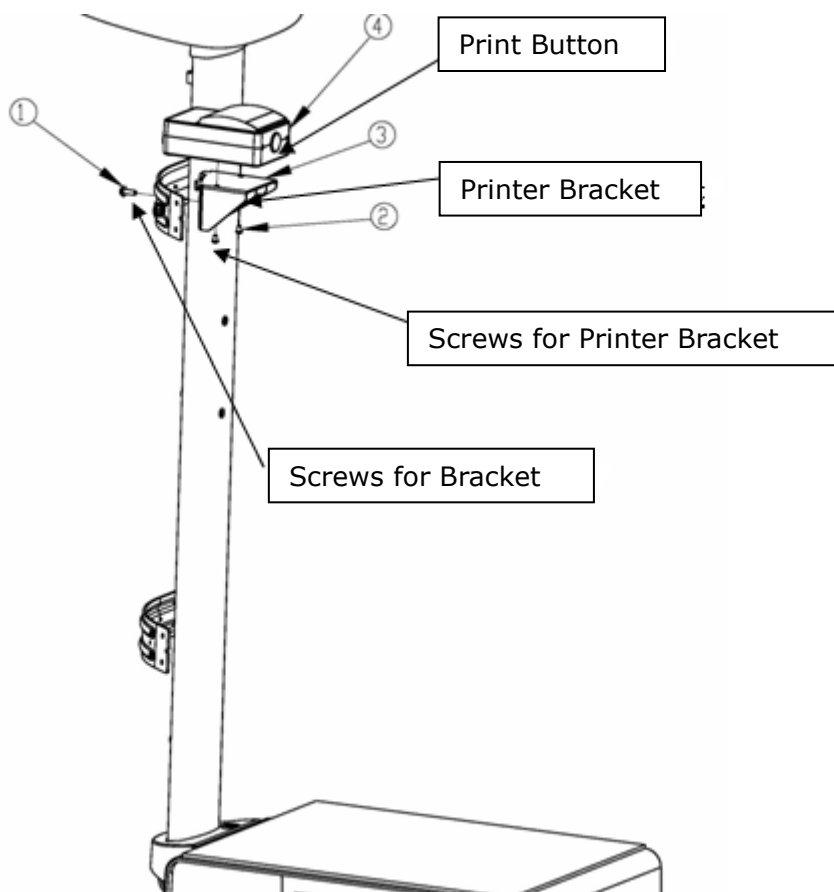

Item	Parts	Qty
1	M5*15L head screw	1
2	Screws for printer bracket	2
3	Printer bracket	1
4	TP2100/TP2110 Thermal Printer	1 (purchased separately)

1. Install the side bracket



2. Install the thermal printer on the bracket

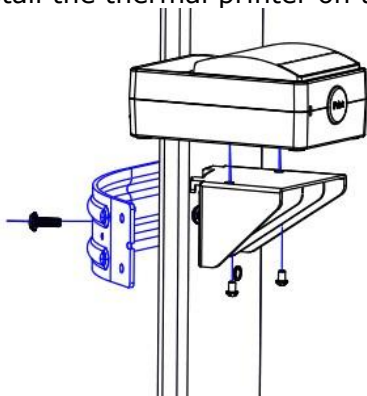

### III. Exterior and Panel

#### A. Quick Guide to components

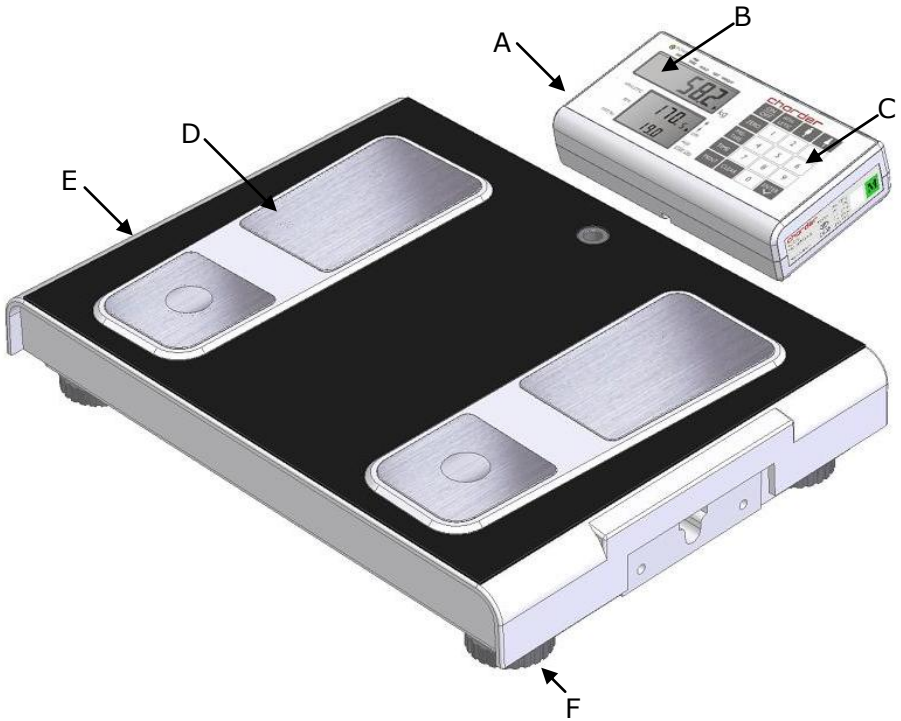



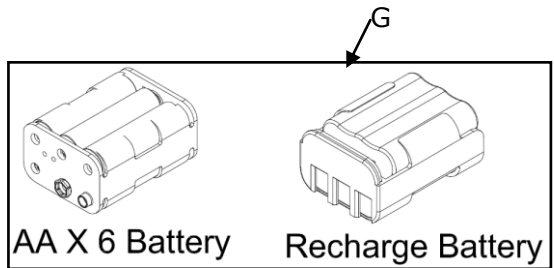



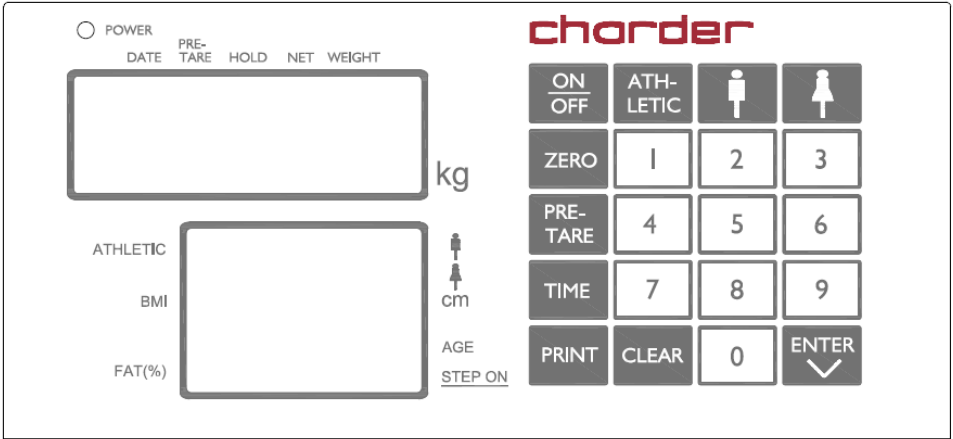

- A: Remote display (DP3710)
- B: Digital LCD
- C: Keypad
- D: Foot Electrodes
- E: Measurement Platform
- F: Adjustable feet
- G: Battery Type



## B. Indicator and Key Functions



### Key Function

1.  **ON/OFF**: Power on or power off.
2.  **ZERO**: Reset display to 0.0 kg display. Press and hold for 3 seconds to enter device settings.
3.  **PRE-TARE**: Pre-tare the known weight of an object (ex: clothing) before beginning measurement.
4.  **TIME**: Set time and date.
5.  **CLEAR**: Clear incorrect data input.
6.  **PRINT**: When printer or PC is connected to the scale, press this key to print results
7.  **ENTER**: Confirm input
8.  -  **0-9**: For entering digits.
9. **BODY TYPE**:

➤  : Male  : Female  : Athletic

### NOTE: selecting appropriate body type

The "Athletic" setting is recommended for subjects that regularly perform

intense physical activity for at least 10 hours per week (or have previously maintained such a habit for an extended period of time), with a resting heart rate of approximately 60 beats per minute or less.

### C. Display layout

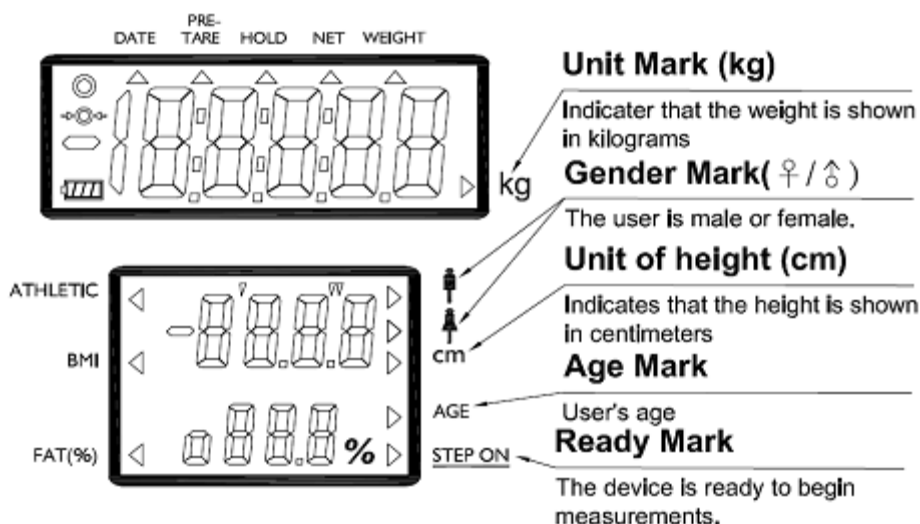
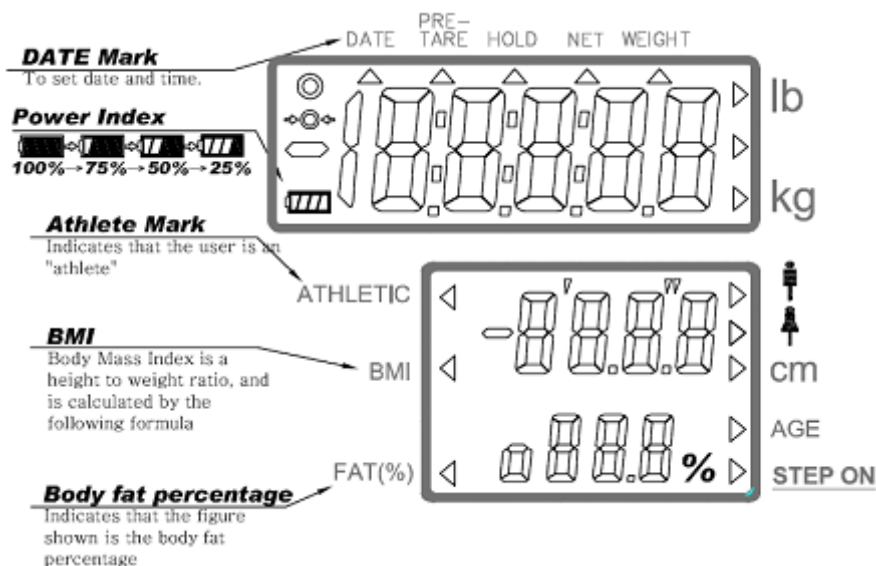

## IV. Using Device

### A. Setup Device for Measurement

To conduct a Body Composition Analysis using the MBF6000/MBF6010, the subject's height, age, and gender needs to be input prior to measurement.

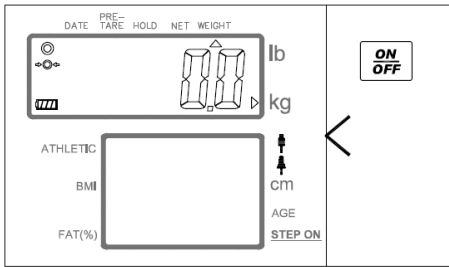

1. Press the **ON/OFF** key. "0.0" will appear on the upper portion of the display.

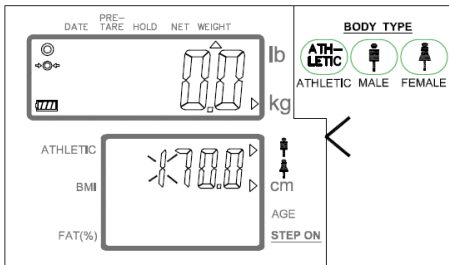

2. Select the body type from standard male, standard female, and athletic. Press **ENTER** to enter setting mode.

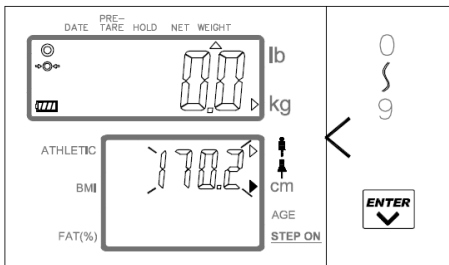



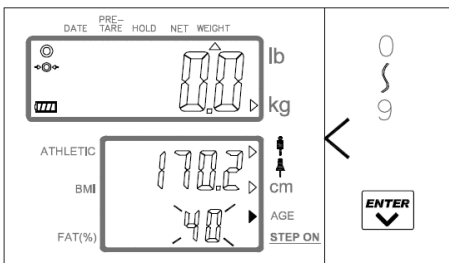



3. Use keypad to enter the subject's height and age when prompted.



## B. Pre-Tare

The Pre-Tare function is used to subtract the known weight of a substance prior to weighing.

DESCRIPTION	EXAMPLE
<p>Press  key. Left-most digit will begin blinking.</p> <p>If no further action is taken within 6 seconds, indicator will return to normal mode</p>	
<p>While digit is blinking:</p> <p>Enter pre-tare weight using 0~9 keys.</p> <p>Ex: to pre-tare 5.0 kg of weight, press 0-0-5-0.</p> <p>Ex: to pre-tare 13.5 kg of weight, press 0-1-3-5.</p> <p>Press  key to confirm the pre-tare weight.</p>	
<p>Indicator will display minus sign to the left of pre-tare weight value.</p>	

**NOTE:** Pre-tare weight must be under max capacity, otherwise screen will show 0.00 after  key is pressed, and the operator will have to re-input pre-tare settings.



## C. Conduct Measurement

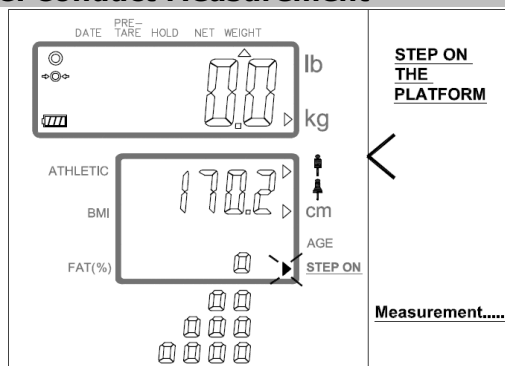

1. When subject's data (gender, height, age) has been input, indicator will display a flashing arrow next to STEP ON when ready.

2. Instruct subject to step on the four electrodes of platform **with bare feet**. Subject should stand in a stable position without bending your knees.

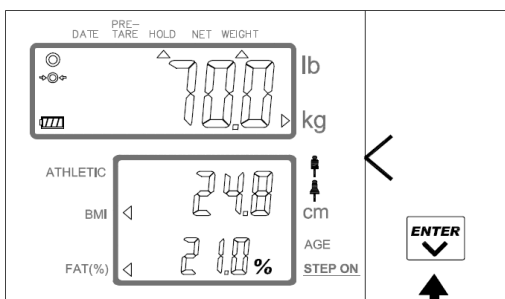

3. After subject has stepped onto weighing platform, weight will be displayed on the LCD. will appear at the bottom of the display, and the impedance measurement will begin. The marks will disappear one by one during the measurement; after three full cycles, the measurement will be complete.

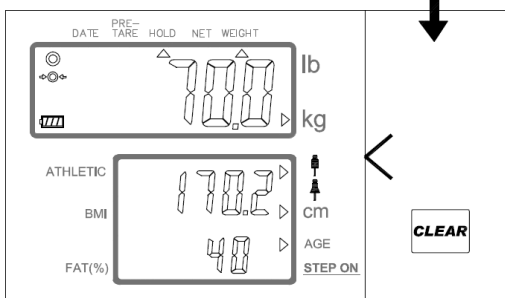

4. The measurement results can be displayed using the key. To conduct additional measurements, press to delete the data, and return to Step 1.

## D. Print

If thermal printer is connected to indicator, results can be printed by pressing  key.

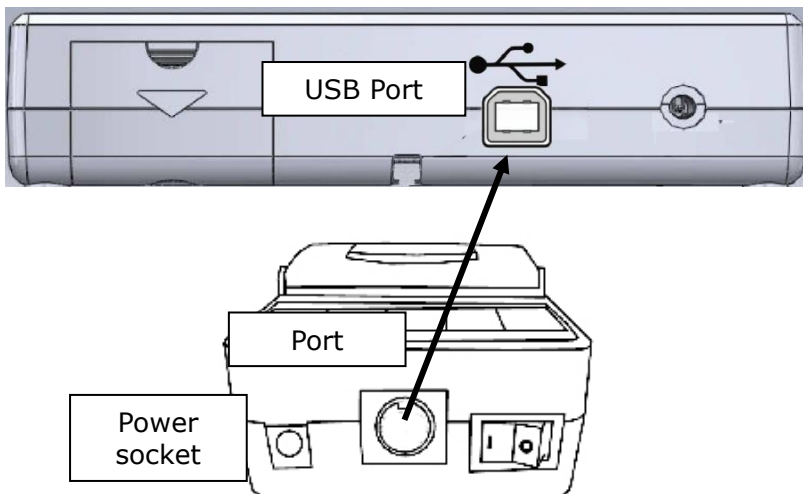

**NOTE:** Thermal printer needs to be powered by adapter

## E. Measurement Results Explained

### BMI (Body Mass Index)

BMI is a commonly used index by the World Health Organization (WHO), utilizing height and weight to classify underweight, normal, over, and obesity in adults.

Category	BMI (kg/m <sup>2</sup> )	Risk of obesity-related disease
Under	< 18.5	Low
Normal	18.5-24.9	Average
Over	24.9-29.9	Slightly Increased
Obese I	30.0-34.9	Increased
Obese II	35.0-39.9	High
Obese III	> 40	Very High

(World Health Organization adult BMI standards)

### FAT% (Body Fat Percentage)

Body fat percentage is useful in determining the specific cause of weight loss or gain. Average percentages differ according to specified groups and categories, most significantly by gender. Although no universally accepted published ranges or cut-off points for body fat percentage currently exist, it is still an important value in assessing change in body composition and health.

### FM (Body Fat Mass)

An essential level of fat is required for the body to function, though excessive fat can result in obesity-related diseases.

### FFM (Fat-Free Mass)

Fat-Free Mass is the weight of the body after deducting total fat mass. In other words, FFM is the weight of everything except body fat.

### BMR (Basal Metabolic Rate)

Basal Metabolic Rate is the minimum required energy to sustain the body's vital functions while at rest. These functions include breathing, blood circulation, regulation of body temperature, cell

Charder	
MBF-6000	
31/03/2009	14:55
BODY TYPE	STANDARD
GENDER	MALE
AGE	40
HEIGHT	170.2 cm
PRE-TARE	0.0 kg
NET WEIGHT	70.0 kg
BMI	24.7
FAT%	21.0 %
FM	14.7 kg
FFM	55.3 kg
BMR	1660 kcal
TBW	40.6 kg
IMPEDANCE	402.2ohm

(Simplified sample print-out for reference only)

growth, brain function, and nerve function. BMR tends to decrease with age or reduction in weight, and is positively correlated with increase in muscle.

### **TBW (Total Body Water)**

Total Body Water (TBW) refers to the water contained in the tissues, blood, bones, and elsewhere. TBW in a healthy (non-obese) adult can fluctuate by roughly 5% daily, influenced by physiological activity and consumption of food and drink<sup>1</sup>. Due to larger size and muscle mass, healthy adult men have more TBW than women (on average)<sup>2</sup>.

For healthy (non-obese) adults, TBW constitutes ~60% of body weight and ~73% of Fat-Free Mass<sup>3</sup>. However, it is important to note that this percentage is not applicable to children - typically, children have a higher percentage of body water than adults, and TBW levels reportedly decrease further around middle age as part of the aging process<sup>4</sup>. In addition, various diseases can affect body water percentage, including renal deficiency diabetes, cardiac failure, and cancer<sup>5</sup>. Therefore, BIA estimations should be used with particular caution if subject's body water differs significantly from the representative populations used to formulate BIA algorithms.

TBW can be divided into Intracellular Water (ICW) and Extracellular Water (ECW). ICW:ECW proportion for healthy populations is roughly 3:2 (ECW/TBW= $\sim 0.38$ )<sup>6</sup>.

### **BM (Bone Mineral content)**

Higher bone mineral content may be an indicator of higher bone density.

---

<sup>1</sup> Askew EW Present Knowledge in Nutrition (7th ed) 1996, p.98-107

<sup>2</sup> Lesser GT, Markofsky J. Body water compartments with human aging using fat-free mass as the reference standard. 1979. Am J Physiol, 236, p.R215-R220.

<sup>3</sup> Wang ZM, Deurenberg P, Wang W, Pietrobelli A, Baumgartner RN, Heymsfield SB. Hydration of fat-free body mass: review and critique of a classic body-composition constant. The American Journal of Clinical Nutrition. 1999. Vol.69 Issue 5, p.833-841.

<sup>4</sup> Cameron CW, Guo SS, Zeller CM, Reo NV, Siervogel RM. Total body water for white adults 18 to 64 years of age: The Fels Longitudinal Study. 1999. Kidney International Vol.56 Issue 1, p.244-252

<sup>5</sup> Moore FD, Haley HB, Bering EA, Brooks L, Edelman I. Further observations on total body water. Changes of body composition in disease. 1952. Surg Gynecol Obstet, 95, p.155-180

<sup>6</sup> Tai R, Ohashi Y, Mizuiuri S, Aikawa A, Saki K. Association between ratio of measured extracellular volume to expected body fluid volume and renal outcomes in patients with chronic kidney disease: a retrospective single-center cohort study. BMC Nephrology, 2014;15:189

### **MM (Muscle Mass)**

Increase in muscle mass increases BMR, which in turn allows the body to burn calories more quickly.

### **PM (Protein Mass)**

The total amount of protein in the body.

### **SM (Skeletal Muscle)**

Cardiac muscle, smooth muscle, and skeletal muscle are the three major muscle types found in the body. Skeletal muscle mass correlates with athletic performance, as it is under voluntary control and used to power movement. In addition, it can be developed actively through proper nutrition and training, thus making this value an important indicator for evaluation of fitness progression.

### **HS (Health Score)**

The overall health score is calculated using the body composition readings. It works on a percentage basis, with 100 being the highest possible score attainable.

### **VFA (Visceral Fat Level)**

Abdominal fat can be divided into visceral and subcutaneous fat. Visceral obesity can occur even if a subject's weight or BMI is within normal standards. Such subjects are thin on the outside, but fat on the inside<sup>7</sup>. Visceral fat level has high correlation with risk of a variety of obesity-related diseases, including cardiovascular diseases and Type-2 diabetes<sup>89</sup>.

### **AGEM (Metabolic Age)**

The subject's Basal Metabolic Rate is compared to average BMR for his/her age and gender group.

---

<sup>7</sup> Dudeja V, Misra A, Pandey RM, Devina G, Kumar G, Vikram NK. BMI does not accurately predict overweight in Asian Indians in northern India. *Br J Nutr.* 2001;86:105-112

<sup>8</sup> Sandeep S, Gokulakrishnan K, Velmurugan K, Deepa M, Mohan V. Visceral & subcutaneous abdominal fat in relation to insulin resistance & metabolic syndrome in non-diabetic south Indians. *Indian J Med Res.* 2010;131:629-635.

<sup>9</sup> Klein S. The case of visceral fat: argument for the defense. *J Clin Invest.* 2004;113(11):1530-1531

## IMPEDANCE

In the conventional 4-electrode foot-to-foot BIA method, current is supplied from the electrodes at the tips of the toes on both feet, with the voltage measured on the heel. This current flows from one lower limb through the lower abdomen and then into the other lower limb, and the bioelectrical impedance is measured. For reference, the impedance measurement methods for the legs are shown in the diagram.

The MBF-6000/6010 measures impedance at 50kHz to calculate body composition results.

### F. About Bioelectrical Impedance Measurement

The MBF6000/MBF6010 uses Bioelectrical Impedance Analysis (BIA) to calculate body composition. At its core, BIA operates by treating the human body as an electrical conductor within an alternating current circuit, from which the alternating current resistance and impedance is measured.

Using a combination of existing population data and in-house research, body composition analysis formulas can calculate results based on the Impedance, Height, Gender, Age, and Weight of the subject. These algorithms are formulated with reference to "gold standard" measurements such as Dual-Energy X-ray Absorptiometry (DXA) to confirm viability and accuracy.

### Measurement Rules

For best results, body composition analysis via BIA should be conducted under specific conditions. Inconsistent measuring conditions will affect the accuracy and validity of BIA results, and interpretation of body composition. The information below regarding the effect of various factors on measurement results is largely sourced from related research by Kushner et al<sup>10</sup>. Before measurement, please take note of the following:

#### 1. Do not exercise or perform strenuous physical tasks before measurement

Strenuous physical tasks and exercise can result in a temporary change

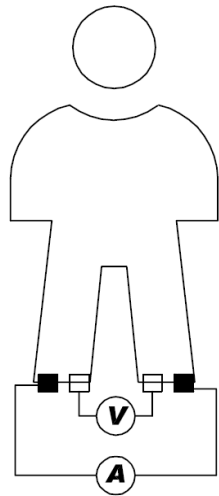

<sup>10</sup> Kushner RF, Clinical characteristics influencing bioelectrical impedance analysis measurements, 1996

in body composition measurements. As BIA analyzes electrical impedance in the body, activities that might affect impedance (e.g. increased perspiration, dehydration, blood circulation) may affect measurement accuracy.

## **2. Affect of food and drink on measurement results**

Ingestion of food and drink can affect impedance and weight, and thus analysis results. This change generally lasts 2-5 hours after each meal. For most accurate results, BIA measurements should ideally be conducted in a fasting state (e.g. before breakfast)<sup>11</sup>.

## **3. Do not shower or bathe directly before measurement.**

Perspiration can result in a temporary change in body composition measurements, as the accuracy of BIA depends largely upon interpretation of measured impedance values, which are affected greatly by hydration levels.

## **4. Perform the measurement under normal temperature conditions (24-28°C)**

Extreme temperatures (both hot and cold) can result in temporary physiological changes. For example, excessive sweating due to heat can cause increased impedance measurements, resulting in a higher fat calculation. For best results, measurements should be conducted in an environment between 24-28°C.

## **5. Remove shoes and socks before measurement.**

Shoes and socks will interfere with the electric current, making measurement inaccurate or in some cases, impossible.

## **6. Avoid physical contact with other people during measurement.**

Because BIA measures the impedance encountered as the electric current travels through the subject's body, if another individual is touching the subject, the electric current may pass through the other individual, causing inaccuracy in measurement results.

## **7. Measure height accurately**

Inaccurate height input will affect estimation of body composition.

## **8. Perform the measurement in the morning.**

As a general rule, BIA measurements should be performed in the morning

---

<sup>11</sup> R Gallagher, M & Walker, Karen & O'Dea, K. The influence of a breakfast meal on the assessment of body composition using bioelectrical impedance. European journal of clinical nutrition. 52. 94-7.

to minimize the influence of activity throughout the day on measurements<sup>12</sup>.

## V. Device Setup

### A. Setting Time & Date

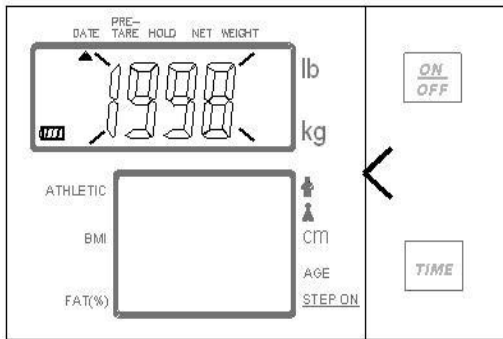

1. Press **ON/OFF** key to power on the device.

2. Press **TIME** key once.

3. The date input screen will appear. The upper row of numbers represents years (YYYY).

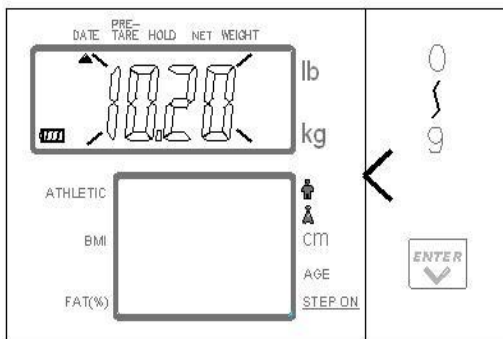

4. Input year in the flashing space. Press **TIME** to enter the date.

Example: To input 2020, Oct 20, 6:28pm, press the following keys in order:

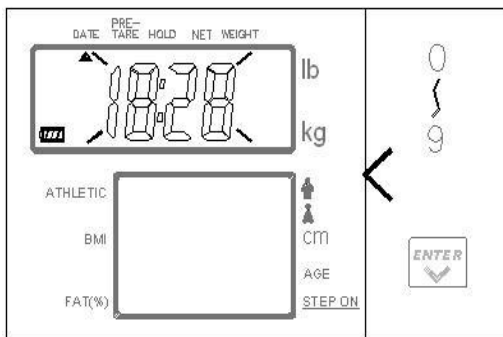
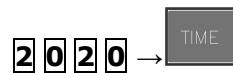

5. Press **TIME** key. The date and time are set, and the clock function is running. The display will now return to the step prior to entering this mode.



<sup>12</sup> Oshima Y & Shiga T. Within-day variability of whole-body and segmental bioelectrical impedance in a standing position, European Journal of Clinical Nutrition 2006, 60, 938-941





## B. Device Setup

When the device is switched on, press and hold the  key for about 3 seconds, until the display shows the "SETUP", followed by "A.OFF" (first option in setting menu).

In device setup menu:

-  to toggle next menu option
-  to toggle previous menu option
-  to confirm selection / enter submenu

After selecting menu option:

-  key to toggle between options
-  key to confirm selection



**Auto Power-Off:** Instruct device to shut off automatically after a certain period of time.

Auto off options: 120 sec / 180 sec / 240 sec / 300 sec / off

Press  to toggle, and  key to confirm selection.





**Buzzer/Beep:**

When function is turned on, beeping noise will be made when: indicator is turned on, keys are pressed, and weight is stable.

Press  to toggle on/off, and  key to confirm selection.

**Language:** Set thermal printer language

Press  to toggle between English and Polish. Press  key to confirm selection.



**Bluetooth (optional):** If device has Bluetooth module installed, Bluetooth function can be turned on or off.

Press  to toggle on/off, and  key to confirm selection.

**Wi-Fi (optional):** If device has Wi-Fi module installed, Wi-Fi function can be turned on or off.

Press  to toggle on/off, and  key to confirm selection.

**Wi-Fi Setting (optional):** If device has Wi-Fi module installed, this option will appear.

Press  to toggle between "Auto" and "PKEY". Press  to confirm selection.

If "Auto" is selected, weight measurement will be automatically sent to connected printer or device. If "PKEY" is selected, transfer will occur manually only after  key is pressed.

# VI. Setup USB Connection to PC

## A. Hyper Terminal

For successful connection, PC hardware connected to device must be compatible with USB 2.0 or above. Operators should select a USB cable length that is most suitable to the operating environment.

1. Connect USB cable to device indicator and PC.
2. Hyper Terminal software is required to connect the MBF-6000/6010 to a PC. If Hyper Terminal is not installed on operator's PC, please download software program from Charder website.

<https://www.chardermedical.com/download.htm>

3. After operating the device to measure weight and BMI, run Hyper Terminal program with the following steps:

1) Click on [**Start**] button, and navigate the menus:

All Programs → Accessories → Communications → HyperTerminal

4. New Connection

Description

Name the connection and click [**OK**]



5. Select COM Port on PC

Click [**Connect To**] to select COM port on PC. Select Bluetooth Port for connection port. Click [**OK**].



6. Port Settings for Printout  
 Input printer port parameter settings as below:

- Baud rate: 9600 bps
- Parity check: none
- Data length: 8 bits
- Stop bit: 1 bit
- Handshake: RTS/CTS
- Date code: ASCII

Click **[OK]** to complete settings.

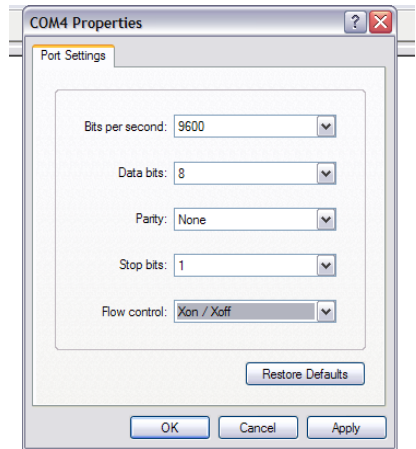

7. Print out data through USB connector

The PC will retrieve weight & BMI data from the device, displayed on the terminal similar to the layout output by the thermal printer.

While the Hyper Terminal program is running, type **[P]** on the PC's keyboard to transmit a print command to the thermal printer connected to the device to print a hard copy.

Or, press the **[PRINT]** button on the display panel of the device.

## Charder

MBF-6000  
 31/03/2009 14:55

BODY TYPE	STANDARD
GENDER	MALE
AGE	40
HEIGHT	170.2 cm
PRE-TARE	0.0 kg
NET WEIGHT	70.0 kg
BMI	24.7
FAT%	21.0 %
FAT MASS	14.7 kg
FFM	55.3 kg
BMR	1660 kcal
TBW	40.6 kg
IMPEDANCE	402.2ohm

(Simplified sample print-out for reference only)

## VII. Wireless Connection

If the MBF6000/MBF6010 is a wireless model, the indicator can transmit measurement results wirelessly. Please see Charder wireless software for details. Device should be integrated with systems by qualified distributor only.

## VIII. Troubleshooting

Before contacting your local Charder distributor for repair service, we recommend considering the following troubleshooting procedures:

### Self-inspection

#### 1. Device will not power on

- If battery power is depleted, replace with new batteries
- If batteries are not used, check if the power adapter is plugged into the device properly. Check if power adapter is plugged into mains properly

#### 2. Indicator showing "0000" ZERO SPAN out of range

- Interference due to factors such as RF disturbance or ground vibration. Relocate device to location without interference and try again
- Unstable platform feet - adjust platform feet according to bubble level indication (clockwise to retract, counter-clockwise to extend) and try again
- External objects interfering with measurement platform. Clear platform of objects and try again
- Device may not function properly on soft surfaces such as carpets or lawns. Relocate device to location with solid, stable floor
- If the steps above cannot resolve the problem, re-calibration may be required to correct weighing accuracy

#### 3. Connection failure for data transmission to PC or printer

- Ensure wires are connected correctly between indicator and PC or printer
- Ensure printer is supplied with power. Ensure PC software is set up properly as indicated in this manual

## Distributor support required

If the following errors occur, we recommend contacting your local Charder distributor for repair or replacement services:





### 1. Device will not power on





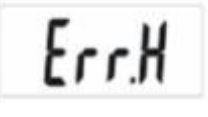

- Faulty on/off key
- Broken or damaged wires causing short circuit or faulty connection
- Safety fuse burnout
- Faulty adapter

### 2. Indicator damage

- Possible hardware defects include: uneven brightness in LCD screen, blurred text, smeared rainbow screen, incorrect decimal display
- Unable to save or read data
- Indicator shows "ERRL" after device is switched on
- Keys not responding
- Buzzer malfunction

## Error Messages

Error Message	Reason	Action
	<b>Low battery warning</b> Voltage of battery is too low to operate device	Replace batteries, or plug in adapter
	<b>Overload</b> Total load exceeds device's maximum capacity	Reduce weight on measurement platform and try again
	<b>Counting Error (too high)</b> Signal from loadcells too high	Error normally caused by faulty loadcell or wiring. Please contact distributor
	<b>Counting Error (too low)</b> Signal from loadcells too low	Error normally caused by faulty loadcell or wiring. Please contact distributor
	Zero count over calibration zero range +10% while power on	Re-calibration required. Please contact distributor

	Zero count under calibration zero range -10% while power on	Re-calibration required. Please contact distributor
	<b>Program Error</b> Fault with device software	Please contact distributor
	<b>Program Error</b> Fault with device software	Please contact distributor
	<b>Impedance Error</b> Impedance exceeds measurement limits	Try measurement again. Contact distributor if problem persists
	<b>Impedance Error</b> Impedance cannot be measured	Try measurement again. Contact distributor if problem persists
	<b>Result Error</b> Calculated results are invalid	Try measurement again. Contact distributor if problem persists
	<b>Impedance Error</b> Impedance exceeds measurement limits	Try measurement again. Contact distributor if problem persists

## IX. Product Specifications

### A. Device Information

<b>Model</b>		<b>MBF6000 / MBF6010</b>
<b>Weight Measurement</b>	<b>Capacity</b>	300 kg x 0.1 kg
	<b>Accuracy</b>	Impedance $\pm$ 3%
	<b>Weight Unit</b>	kg (OIML) , kg / lb (CE model)
	<b>LCD Screen</b>	0.8-inch LCD screen (Three row LCD)
	<b>Key Functions</b>	On/Off, Zero, Pre-Tare, Body Type, 0~9, Clear, Enter, Time, Print
<b>Impedance Measurement</b>	<b>System</b>	4-electrode Bioelectrical Impedance Analysis
	<b>Current</b>	50kHz 500uA
	<b>Style</b>	Left leg-Right leg Foot-to-foot
	<b>Measurement Range</b>	200 ~ 1000 $\Omega$ / 0.1 $\Omega$
<b>Input Items</b>	<b>Gender</b>	Male / Female
	<b>Body Type</b>	Standard / Athletic
	<b>Age</b>	10 ~ 80 years old
	<b>Height</b>	60 ~ 210cm / 3ft ~ 7ft 11.0in
<b>Dimensions</b>	<b>Overall</b>	450(W) x 450(D) x 970(H) mm
	<b>Platform</b>	450(W) X 340(D) X 90(H) mm
	<b>Column</b>	(MBF6010 only) 850 mm
<b>Device Weight</b>		(MBF6000) 8.6 kg (MBF6010) 10.2 kg
<b>Data Transmission</b>		USB, Wireless Module (optional) <b>NOTE:</b> Device should be connected to network by qualified distributors only
<b>Power Supply</b>		7.2V 2000mA rechargeable battery or 6 AA batteries / adapter
<b>Operation Temperature &amp; Humidity</b>		0°C~40°C 30% / 80% RH
<b>Standard Accessories</b>		User manual x 1; Power Adapter x 1; USB cable x 1
<b>Optional Accessories</b>		Thermal Printer, Height Meter



## B. Output Items (Display and Print-out)

<b>MODEL</b>		MBF6000 / MBF6010
<b>Serial Number</b>		C12345678 (example)
<b>Date/Time</b>		DD/MM/YYYY hh:mm EX: 30/10/2020 10:55
<b>Body Type</b>		Standard / Athletic
<b>Gender</b>		Male / Female
<b>Age</b>		10 ~ 80 years old / 1 year increments
<b>Height</b>		60 ~ 210cm / 3ft ~ 7ft 11.0in
<b>Preset Tare</b>		0 ~ 299 kg
<b>Net Weight</b>		0 ~ 300 kg
<b>BMI</b>	Body Mass Index	0.1 increments
<b>BF %</b>	Body Fat Percentage	5 ~ 50% / 0.1% increments
<b>FFM</b>	Fat-Free Mass	0.1kg increments
<b>FM</b>	Fat Mass	0.1kg increments
<b>BM</b>	Bone Mineral	0.1kg increments
<b>MM</b>	Muscle Mass	0.1kg increments
<b>BMR</b>	Basal Metabolic Rate	1 kcal increments
<b>TBW</b>	Total Body Water	0.1L increments
<b>PM</b>	Protein Mass	0.1kg increments
<b>ICW</b>	Intracellular Water	0.1L increments
<b>ECW</b>	Extracellular Water	0.1L increments
<b>SM</b>	Skeletal Muscle	0.1kg increments
<b>HEALTH SCORE</b>		XX.X score
<b>VFALEVEL</b>	Visceral Fat Level	Visceral Fat Level
<b>AGEM</b>	Metabolic Age	XX.X
<b>IMPEDANCE</b>		XXX.X ohm



# Notes

---

---

---

---

---

---

---

---

---

---

---

---

---

---

---

---

---

---

---

---

---

---

---



---

---

---

## X. Declaration of Conformity

This product has been manufactured in accordance with the harmonized European standards, following the provisions of the below stated directives:

	93/42/EEC as amended by 2007/47/EC Medical Device Directive
	2014/31/EU Non-automatic Weighing Instruments Directive

*Please see separate document showing on sticker of device for above CE marking.*

Authorized EU Representative:



**Obelis s.a.**

Bd Général Wahis, 53  
B-1030 Brussels  
Belgium



Manufactured by:  
Charder Electronic Co., Ltd.  
No.103, Guozhong Rd., Dali Dist.,  
Taichung City, 41262 Taiwan (R.O.C.)

CD-IN-1256 14202J 04/2021